

# RADAR LEADER

The Magnetrol® Family of Radar  
Solutions for Level Measurement

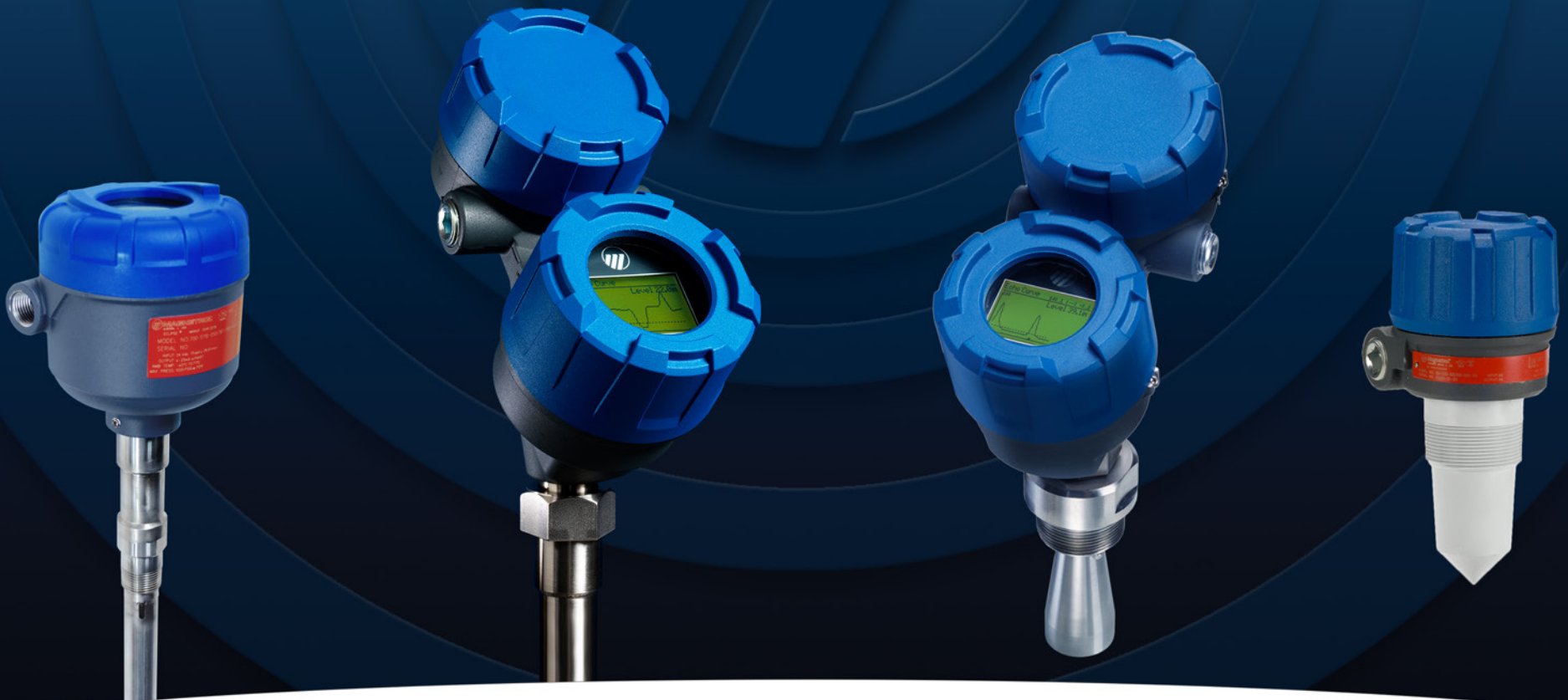

## Your needs are always on our Radar

Magnetrol® is recognized as the global leader in level and flow solutions. But in many process control industries, the name “Magnetrol” has become another word for radar solutions.

That’s understandable, because we never stop thinking about ways to optimize reliability, improve safety and drive efficiency. It is a singular focus that has resulted in radar solutions that changed the industries we serve for the better.

Magnetrol introduced the first loop-powered Guided Wave Radar (GWR) transmitter for industrial liquid level applications. Then, our advancements in Guided Wave Radar created the next frontier of reliable level instrumentation. Now, we are bringing a smarter Non-Contact Radar transmitter that improves performance in demanding conditions.

It is all about meeting your needs in the most effective way possible.

## A complete family of solutions

How can you serve a world of different customers with different applications from different industries? Magnetrol does it with a true family of radar transmitters for all different needs.

This brochure will introduce you to our Guided Wave Radar and Pulse Burst Radar solutions. You’ll learn why the Magnetrol family is trusted wherever and whenever performance, safety and reliability matter.

## Industries we serve

MAGNETROL radar solutions set the performance standard across process control industries. Our innovative instrumentation delivers reliability and accuracy in even the most challenging applications, to ensure the efficiency and safety of your process operation.



## Contents

About Magnetrol . . . . .	2
Guided Wave Radar . . . . .	3
Eclipse® Model 706 . . . . .	4
Eclipse® Model 700 . . . . .	7
Pulse Burst Radar . . . . .	8
Pulsar® Model R86 . . . . .	9
Pulsar® Model R96 . . . . .	11
Model R82 . . . . .	11



## MAGNETROL MILESTONES



**1932**

As the innovator of the first magnetic switch designed for safe, accurate detection of liquid levels, Magnetrol’s origins are tied to level control breakthroughs for industrial process markets.

1932

1960

1980

## Guided Wave Radar technology

Process industries face challenges on a daily basis. They need exceptionally robust level measurement that delivers the required performance under challenging process conditions. Magnetrol helps with those challenges by utilizing loop-powered Guided Wave Radar technology in liquid level applications. Our Guided Wave Radar delivers premier performance because it is virtually unaffected by changing media conditions and can tolerate conditions of turbulence, foaming or boiling and flashing.

### Principle of operation

Guided Wave Radar functions according to the principle of time domain reflectometry (TDR). A generated pulse of electromagnetic energy travels down the probe. Upon reaching the surface of the medium, the pulse is reflected. Sophisticated high-speed circuitry captures these signals and level is calculated based on transmitter configuration.



Our Eclipse® transmitters generate pulses of electromagnetic energy that are **transmitted down** the probe, or waveguide.



When the pulses reach a surface that has a higher dielectric than the air or vapor in which they travel, they are **reflected back up** the probe.

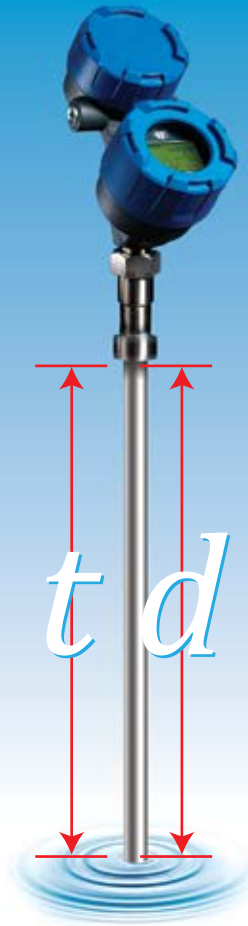

The pulses' **transit time to and from the surface is measured and converted to distance**. Then it is displayed on the LCD as a level reading.



**1998**

The Eclipse® 705 is introduced as the **first loop-powered guided wave radar transmitter** for industrial liquid level applications. It measures and controls challenging media with unprecedented accuracy.

**1998**

**1999**

# ECLIPSE® 706 GWR

## The leading Guided Wave Radar for the most demanding conditions

More than ever, today's process industries require safe, efficient and cost-effective control of applications having extreme temperature and pressure conditions.

Guided Wave Radar (GWR) is the premier technology for those challenging applications, and the Magnetrol Eclipse® Model 706 is the leader in GWR transmitter performance.

### Here are 5 reasons why the ECLIPSE Model 706 has become the choice in GWR:

#### PERFORMANCE

Eclipse Model 706 is virtually unaffected by fluctuating process conditions including density, dielectric, viscosity and specific gravity

#### ACCURACY

You can rely on a superior degree of accurate and reliable continuous level measurement

#### VERSATILITY

There are probe configurations for every application

#### SIGNAL to NOISE RATIO (SNR)

Superior signal strength coupled with patented noise reduction circuitry delivers excellent performance, even in challenging high-pressure, high-temperature applications

#### EASE OF USE

Eclipse Model 706 is simple to use, has no moving parts and requires no calibration



## MAGNETROL MILESTONES



**1999**

Magnetrol drives innovation in the GWR category by releasing the first Eclipse **high-temperature/high-pressure probe**, rated to 750 °F (400 °C).

**1999**

# ECLIPSE® 706 GWR

**No other GWR can eclipse this performance**

## Superior Signal Performance

The Eclipse Model 706's innovative front-end circuitry achieves a higher transmit pulse amplitude and improved receiver sensitivity, resulting in superior signal-to-noise ratio. This assures precise, dependable control for every level application, including extremely low dielectric media, extended measuring ranges, and punishing conditions where foaming, boiling or flashing can occur.

## Probe Configurations for Every Application

The Eclipse Model 706 provides the total range of GWR measurement solutions. An extensive line of dedicated coaxial, single and twin cable probes delivers accurate, reliable level control. The Model 706 is suitable for applications ranging from routine water storage to process media exhibiting corrosive vapors, foam, steam, coating and buildup, surface agitation, bubbling or boiling, high fill/empty rates, low level and varying dielectric or specific gravity conditions.

## Overfill Capable Probes

Magnetrol offers the only GWR transmitter on the market with overfill-capable probes.

Unlike other GWR transmitters, the Model 706 measures true level to within specification all the way up to the process flange. Coaxial and single rod overfill-capable probes can be installed in various configurations, and can bring peace of mind in those applications where the risk of flooding exists.

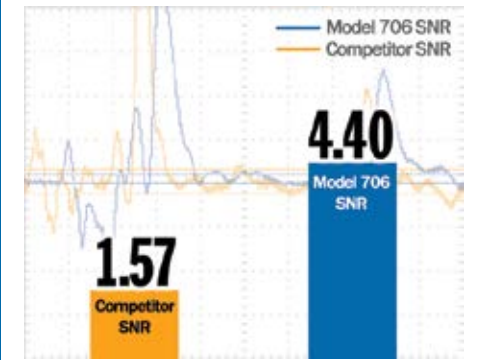

**ALMOST 3 TIMES HIGHER**

The Eclipse Model 706 has a signal-to-noise ratio (SNR) almost 3 times higher than the nearest competitor

Internal reference signal physically and electrically separated from process and media.

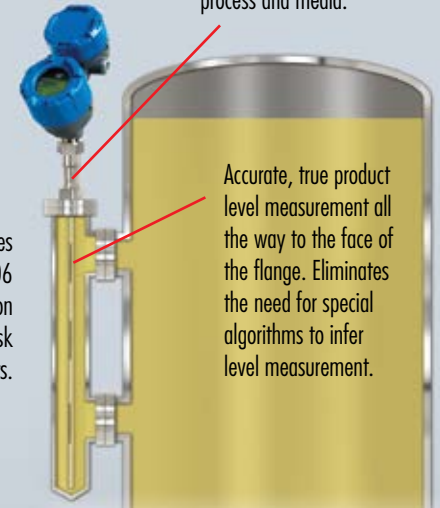

Overfill Capable GWR probes are unique to Eclipse Model 706 and can be installed at any location on the vessel, even when the risk of flooding exists.

Accurate, true product level measurement all the way to the face of the flange. Eliminates the need for special algorithms to infer level measurement.

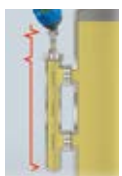

**2000**

Magnetrol releases the first overfill-capable coaxial probe.

**2000**

## Advanced Diagnostics

The Eclipse Model 706 conveys critical real-time waveform and trend data with outstanding ease of use.

- 4-button user interface and graphical LCD display provide enhanced depth of data, indicating on-screen waveforms and troubleshooting tips
- Programming options can be set to automatically capture waveform data by time or by event occurrence
- Conforms to NAMUR NE 107 standards
- User friendly/intuitive DTM

## Exclusive Pre-Configuration

Take the Eclipse Model 706 out of the box, apply 24 VDC and walk away. It's truly that simple.

## Features at a Glance

FEATURE	ECLIPSE 706
Process Temperature Range	-320 to +850 °F (-196 to +454 °C)
Process Pressure Range	Full Vacuum to 6250 psi (430 bar)
Safety Integrity Level (SIL)	SIL 2/3 Certified Safe Failure Fraction (SFF) = 93% (Full FMEDA available upon request)
Digital Communications	HART® 7.0, FOUNDATION fieldbus™, Profibus PA, Modbus
Menu Languages	English, French, German, Spanish, Russian, Polish

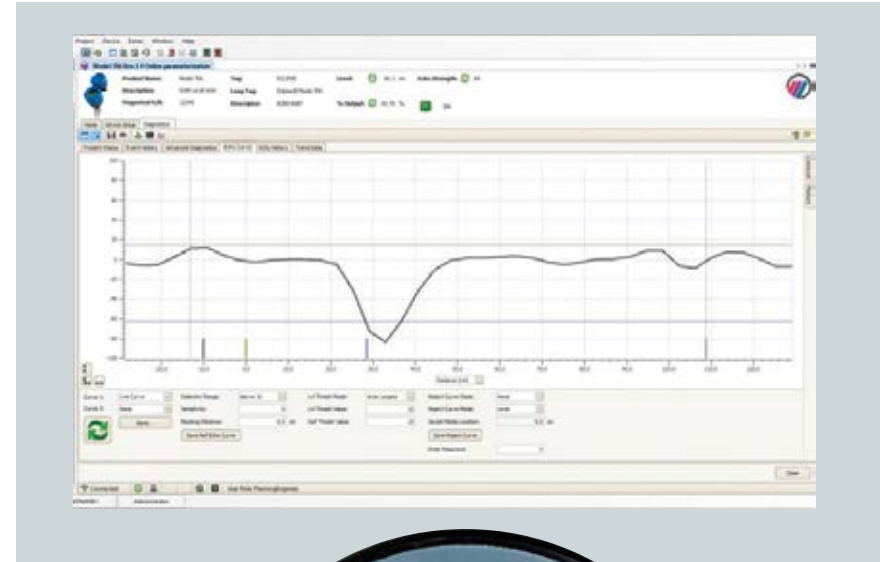

## MAGNETROL MILESTONES



**2001**

Magnetrol becomes the first company to incorporate GWR technology into a patented magnetic level indicator chamber to offer true redundant measurement.

**2001**

**2002**

# ECLIPSE® 700 GWR

The Model 700 is supplied in a more traditional single compartment housing, with the probe an integral part of the assembly. Offering all of the GWR performance and diagnostic advantages of the Model 706, the Model 700 is a more competitively-priced GWR solution for those numerous, more generic applications.

## Features at a Glance

FEATURE	ECLIPSE 700
Process Temperature Range	-320 to +400 °F (-196 to +200 °C)
Process Pressure Range	Full Vacuum to 1000 psi (69 bar)
Safety Integrity Level (SIL)	SIL 2/3 Certified
	Safe Failure Fraction (SFF) = 93% (Full FMEDA available upon request)
Digital Communications	HART® 7.0
Menu Languages	English, French, German, Spanish, Russian, Polish, Portuguese



**2002**

Magnetrol adds a patented **steam probe** to its Model 705 offering. Shortly after in 2005, we introduce the Model 705 interface transmitter.

**2003**



**2003**

The first Pulsar Pulse Burst Radar Transmitter is introduced.

**2007**

# Pulse Burst Radar technology

Pulse Burst Radar operates in the time domain and does not require complex and expensive processing. Because echoes are discrete and separated in time, Pulse Burst Radar is better able to sort through extraneous echoes and select the one generated by true level. Pulse Burst Radar also has excellent averaging characteristics. That's extremely important in applications where the return signal can be attenuated.

## How Pulse Burst Radar works

Unlike TDR devices that transmit a single, sharp (fast rise time) waveform of wide-band energy, Pulsar products emit short bursts of energy and measure the transit time of the signal reflected from the liquid surface.

### Distance is calculated utilizing the equation:

$$\text{Distance} = C \times \text{transit time}/2 \quad (C = \text{speed of light})$$

Level is then calculated based on transmitter configuration. The sensor reference point is the face of the flange.

### Equivalent Time Sampling (ETS)

ETS measures the high-speed, low-power electromagnetic energy (EM). ETS is critical in the application of radar to vessel level measurement. It captures the EM signals in real time (nanoseconds) and reconstructs them in equivalent time (milliseconds).

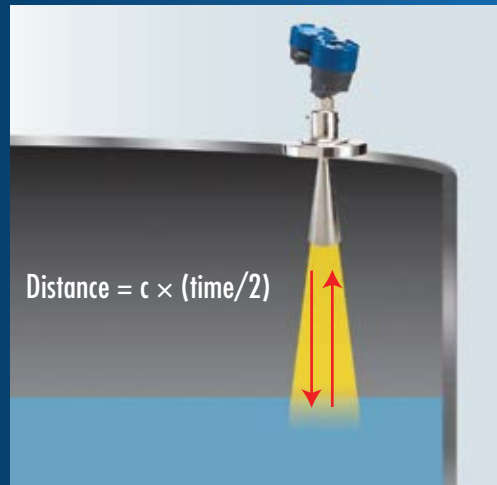

## Managing Common Disturbances

Pulse Burst Radar technology and advanced signal processing help manage:

1. False echoes caused by obstructions, or multi-path reflections caused by radar signals hitting a sidewall
2. Turbulence generated by agitators or aggressive chemical reactions
3. A layer of light to medium density foam

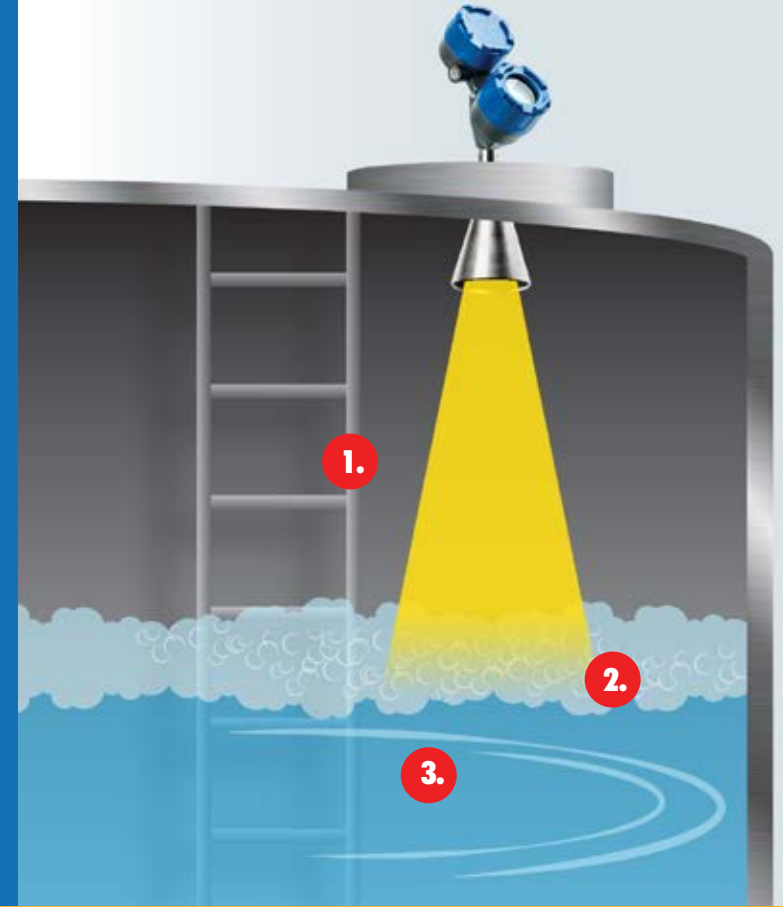

## MAGNETROL MILESTONES



**2009**

The first overfill-capable single rod probe is introduced.

**2009**



**2009**

Magnetrol introduces the Model R82 Pulse Burst Radar Transmitter.

**2010**



# PULSAR® R86 RADAR

## The Non-Contact Radar that is smarter on every level

The PULSAR Model R86 is the first industrial, 26GHz Pulse Burst Non-Contact Radar transmitter from Magnetrol. More importantly, it is the transmitter with the innovations today's process industries need.

### Improved Performance

The 26GHz radar signal has a narrower wavelength allowing for smaller antennas and improved resolution. The smaller antennas allow installation into a process connection as small as 1½".

### HTHP Antennas

For extremely demanding applications and punishing conditions up to 750 °F (400 °C)/2320 psi (160 bar). Nozzle extensions from 4" to 72" (100mm to 1.8m) means nonstandard nozzle lengths and underground vessel standpipes are never a problem.

### Circular Polarization

No need to adjust the antenna to avoid false targets. This simplifies installation and delivers proper alignment in virtually every application.

### Powerful Microprocessor

Offers significant memory for exciting new features, including:

- Volumetric Capability with nine common tank shapes and a 30-point strapping table for uncommonly shaped vessels
- Data Logging that can be programmed to save data/echo curves on event- or time-based conditions

### 26GHz vs. 6GHz

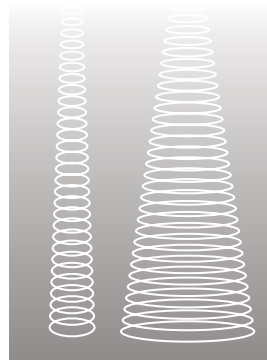

**True Versatility**  
Nozzle extensions from 4" to 72" (100mm to 1.8m)  
and horn antennas from 1.5" to 4"



**2011**

The Eclipse Model 705 receives Exida certification for Safety Integrity Level (SIL) 3 capability per IEC 61508.

**2011**



**2012**

The Eclipse Model 706 is launched, taking the level instrumentation industry to the next frontier of reliable level instrumentation.

**2012**

# PULSAR® R86 RADAR

## Advanced Diagnostics

- Automated Echo Capture conveys real-time waveform and trend data
- 4-Button Interface and Large LCD Display provide enhanced depth of data and on-screen wave forms
- Expanded Event History shows up to 20 events including diagnostic and configuration data
- Troubleshooting Tips help you reduce downtime
- Setup and Echo Rejection Wizards will easily guide you through the process
- Custom Echo Rejection allows you to fit around potential echoes encountered in applications of mixing blades

## SIL 2 capability

SIL 2 hardware compliance is standard. Safe Failure Fraction (SFF) = 93.2%, with third-party FMEDA.

FEATURE	PULSAR R86
Operating Frequency	26 GHz
Process Temperature Range	To 750 °F (400 °C)
Process Pressure Range	To 2320 psi (160 bar)
Measuring Range	130 feet (40 meters)
Measured Error	±0.1 (±3 mm)
Resolution	1 mm
Nozzle Extensions	To 72" (1.8 meters)
Horn Antennas	1 ½" to 4"
Digital Communications	HART® 7.0, FOUNDATION fieldbus™, Profibus PA
Menu Languages	English, French, German, Spanish, Russian, Polish, Portuguese, Mandarin
Safety Integrity Level (SIL)	SIL 2 Capable, SFF = 93.2%



## MAGNETROL MILESTONES

2014 2016



**2016**

The Pulsar R96 launches. This advanced Non-Contact Radar delivers accurate, reliable level control in process applications.

## More Pulse Burst Radar solutions

### Pulsar® Model R96 Non-Contact Radar Transmitter

6GHz model for heavy industrial applications.

#### Applications

##### Media:

- Liquids and Slurries
- Hydrocarbons to Water-Based Media

##### Vessels:

- Process and Storage Vessels up to rated temperature and pressure
- Pits and Sumps

#### Features

- Performance not process dependent
- Antenna designs to +400 °F (+204 °C)
- Range up to 130 feet (40 meters)
- Quick connect/disconnect probe coupling allows vessel to remain sealed
- SIL 2 capable with Safe Failure Fraction (SFF) = 92.7% (FMEDA available upon request)
- New improved Device Type Manager (DTM).

#### Options

- HART® 7.1 and FOUNDATION fieldbus™ digital communications
- 316 stainless steel dual-compartment enclosure
- 3", 4" and 6" horn antennas
- Polypropylene and Teflon® rod antennas
- Antenna nozzle extensions

### Model R82 Pulse Burst Radar Transmitter

26GHz model for light industrial applications.

#### Applications

##### Level:

- Storage and Intermediate Holding Tanks
- Standpipes and Chambers
- Mixing and Blending Vessels
- Enclosed Sumps

##### Open Channel Flow:

- Enclosed Flumes and Weirs

#### Features

- 24 VDC, loop-power with HART®
- Range: 15 inches (380 millimeters) to 40 feet (12 meters) measured from process connection
- Antenna: Encapsulated horn — polypropylene or Tefzel®
- Process Temperature: -40 to +200 °F (-40 to +93 °C)
- Process Pressure: Vacuum to 200 psi (-1 to 13.8 bar)

#### Options

- General Purpose and Intrinsically Safe approvals
- Lexan or cast aluminum, single compartment housing
- ¾" NPT or M20 conduit connections
- Process Connections: 2" NPT or BSP
- Antenna extensions for nozzle heights up to 12" (300 mm)



2017



2017

The Pulsar R86 introduces a new level of performance. This 26GHz Non-Contact Radar has a smaller wavelength for smaller antennas and improved 1mm resolution.

2020



2020

The Eclipse Model 700 guided wave radar transmitter is introduced.



CORPORATE HEADQUARTERS

705 Enterprise Street • Aurora, Illinois 60504-8149 USA • Phone: 630-969-4000  
magnetrol.com • info@magnetrol.com

---

*Magnetrol, Magnetrol logotype, Eclipse and Pulsar are registered trademarks of Magnetrol International, Incorporated.*

*HART is a registered trademark of the HART Communication Foundation. FOUNDATION fieldbus logo is a registered trademark of the Fieldbus Foundation.*

*Teflon and Tefzel are registered trademarks of E.I. du Pont de Nemours and Company.*

*Copyright ©2020 Magnetrol International, Incorporated.*

*Bulletin: 41-150.2 • Effective: April 2020*